

Power relay K (open and sealed)



Description

Features

- High continuous current
- Wide voltage range

Typical applications

- Lamp control circuits
- Seat adjustment motors
- Window defoggers
- Starter solenoid switches etc.

Please contact Tyco Electronics for relay application support.

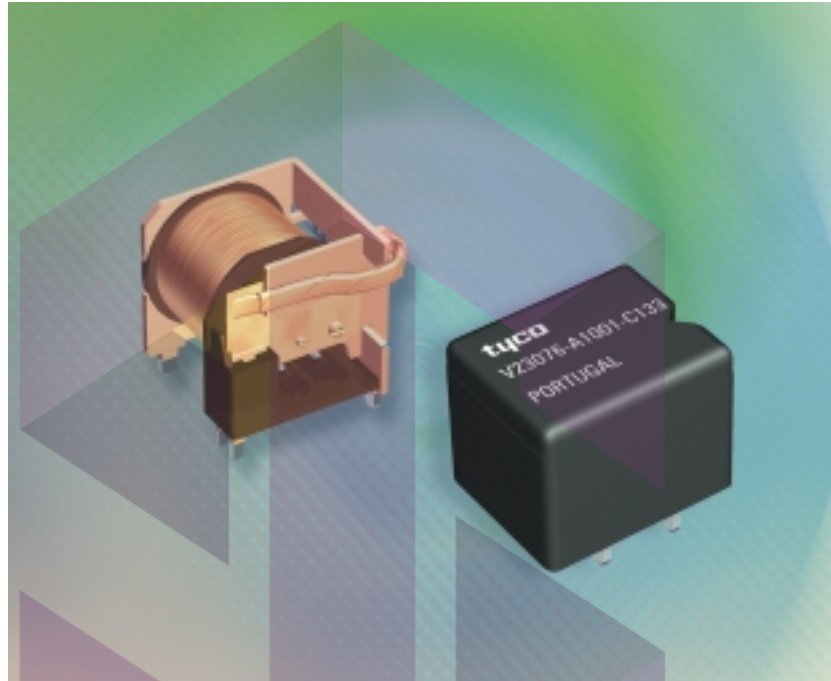

133_3d01/76_3d01



~~Car Industry~~



Truck Industry



~~Other Industry~~

Design

Open or sealed;
sealed version: sealing in accordance with IEC 68;
immersion cleanable: protection class IP 67 to IEC 529 (EN 60 529)

Weight

Approx. 0.67 oz. (19 g) open version
Approx. 0.77 oz. (22 g) sealed version

Nominal voltage

12 V or 24 V;
other nominal voltages available on request

Terminals

PCB terminals, for assembling in printed circuit boards

Conditions

All parametric, environmental and endurance tests are performed according to EIA Standard RS-407-A at standard test conditions unless otherwise noted:
23 °C ambient temperature,
20-50% RH, 29.5 ± 1.0" Hg (998.9 ± 33.9 hPa).
Please also refer to the Application Recommendations in this catalog for general precautions.



تهیه و توزیع قطعات الکترونیک

Disclaimer

All technical performance data apply to the relay as such, specific conditions of the individual application are not considered. Please always check the suitability of the relay for your intended purpose. We do not assume any responsibility or liability for not complying herewith. We recommend to complete our questionnaire and to request our technical service. Any responsibility for the application of the product remains with the customer only. All specifications are subject to change without notification. All rights of Tyco are reserved.

Power relay K (open)

Dimensional drawing

Open version

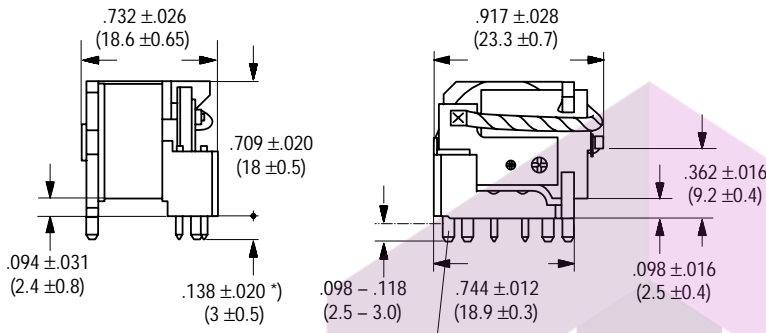

*) additional tin tops
max. .59 inch (1.5 mm)

Mounting holes

View of the terminals (bottom view)

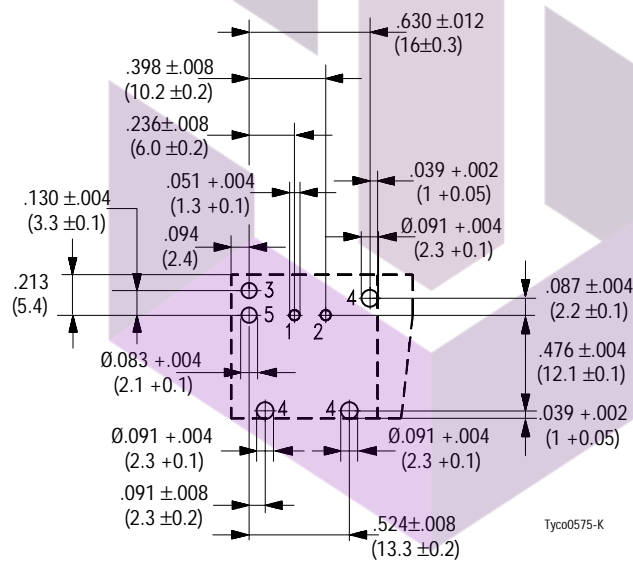

SKYTECH

تهیه و توزیع قطعات الکترونیک

Power relay K (sealed)

Sealed version

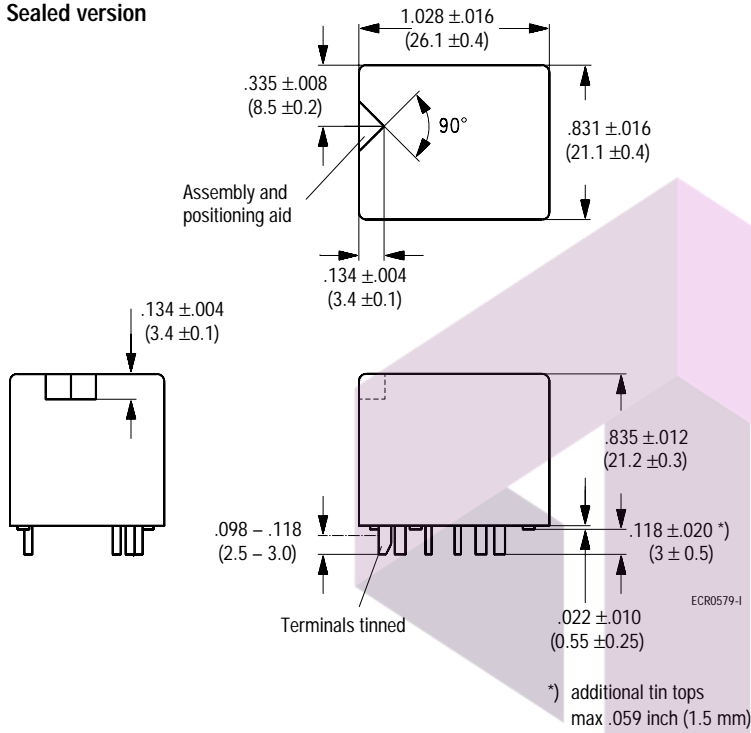

View of the terminals (bottom view)

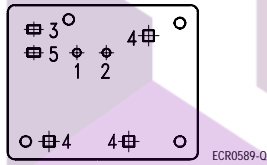

Mounting holes

View of the terminals (bottom view)

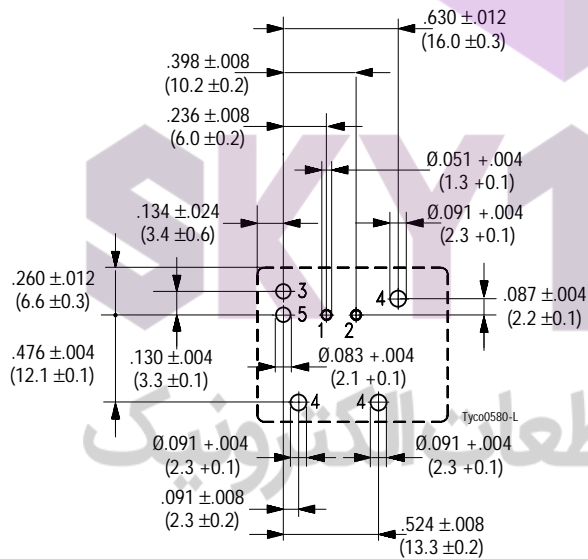

Power relay K (open and sealed)

Contact data

Typical areas of application	Resistive / inductive loads		Indicator lamps V23133-A3*-D152	Headlights, capacitive loads	
	Make contact/ Form A	Changeover contact/ Form C	Make contact/ Form A	Make contact/ Form A	Changeover contact/ Form C
Contact configuration					
Circuit symbol (see also Pin assignment)					
Rated voltage	12 V	12 V	12 V	12 V	12 V
Rated current at 85°C	30 A	NC/NO 25/30 A	25 A	25 A	NC/NO 20/25 A
Contact material	AgNi0.15			AgSnO ₂	
Max. switching voltage/power			See load limit curve		
Max. switching current ¹⁾					
On ²⁾	100 A	NC/NO 30/100 A	120 A ³⁾	180 A	NC/NO 60/180 A
Off	60 A	30/60 A	60 A	60 A	30/60 A
Minimum recommended switching current ⁴⁾	1 A at 5 V				
Voltage drop at 10 A (initial)	Typ. 20 mV, 300 mV max.				
Mechanical endurance (without load)	> 10 ⁷ operations				
Electrical endurance (example of resistive load)	> 2 x 10 ⁵ operations at 13.5 V / 40 A		> 2.2x 10 ⁶ operations up to 8 x 21 W	> 10 ⁵ operations up to 4 x 60 W	

¹⁾ The values apply to a resistive or inductive load with suitable spark suppression and at maximum 13.5 V for 12 V or 27 V for 24 V load voltages.

²⁾ For a load current duration of maximum 3 s for a make/break ratio of 1:10.

³⁾ Corresponds to a peak inrush current on initial actuation (cold filament).

⁴⁾ See chapter Diagnostics in our Application Recommendations on page 18.

Load limit curve

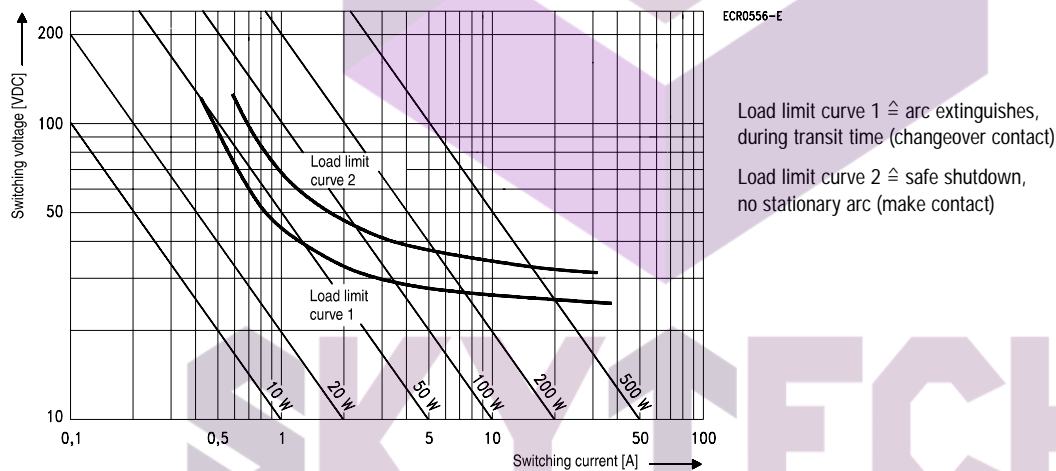

Pin assignment

1 make contact/
1 form A

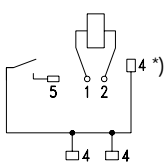

ECR1081 - B

1 changeover contact/
1 form C

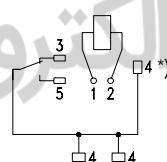

ECR1086 - A

*) Terminal 4 to be bridged

Power relay K (open and sealed)

Coil data

Available for nominal voltages	12 V
Nominal power consumption of the unsuppressed coil at nominal voltage	1.6 W
Test voltage winding/contact	500 VAC _{rms}
Maximum ambient temperature range	- 40 to + 85 °C
Operate time at nominal voltage	Typ. 5 ms
Release time at nominal voltage ¹⁾	Typ. 3 ms

¹⁾ For unsuppressed relay coil
N.B.

A low resistive suppression device in parallel to the relay coil increases the release time and reduces the lifetime caused by increased erosion and/or higher risk of contact tack welding.

Operating voltage range

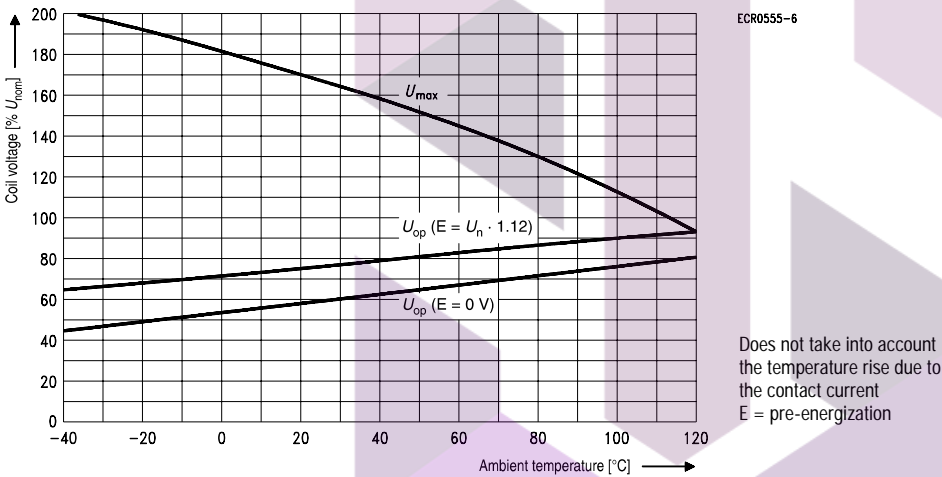

Mechanical data

Enclosures Sealed	Sealed relay is suitable for immersion cleaning of PCB assembly or conformal coating. Please refer to the Application Recommendations in this catalog.
----------------------	---

Operating conditions

Temperature range, storage	-40 °C to 155 °C			
Test	Relevant standard	Testing as per	Dimension	Comments
Climatic cycling with condensation ¹⁾	EN ISO 6988		3 cycles	Storage 8/16 h
Temperature cycling ¹⁾	IEC 68-2-14	Na	20 cycles	- 40/+ 85 °C (dwell time 1 h)
Damp heat ¹⁾				
cyclic	IEC 68-2-30	Db, Variant 1	6 cycles	Upper air temperature 55 °C
constant	IEC 68-2-3	Ca	56 days	
Corrosive gas ¹⁾	IEC 68-2-42 IEC 68-2-43	-	10 days 10 days	
Vibration resistance	IEC 68-2-6 (sine pulse form) acceleration, acc. to position		10 ... 200 Hz	No change in the switching state > 10 µs
Shock resistance	IEC 68-2-27 (half-sine pulse form) acceleration		20 ... 40 g 8 ms 30 g	
Solderability	IEC 68-2-20	Ta, Method 1		
Resistance to soldering heat	IEC 68-2-20	Tb, Method 1A		Aging 3 (4 h/155 °C) Dewetting 10 s ± 1 s with thermal screen
Sealing ¹⁾	IEC 68-2-17	Qc, Method 2		1 min/70 °C

¹⁾ Only sealed version

Power relay K (open and sealed)

Ordering information

Part numbers (see table below for coil data)		Contact arrangement	Contact material	Enclosure	Terminals	
Relay part number	Tyco order number					
12 V pcb relays						
V23133-A1001-C133	1393278-7	Form C	AgNi0.15	Open	Printed circuit	
V23133-A1001-D143	1-1393278-3	Form C	AgSnO2	Open	Printed circuit	
V23133-A3001-C132	5-1393278-7	Form A	AgNi0.15	Open	Printed circuit	
V23133-A3001-D142	5-1393278-9	Form A	AgSnO2	Open	Printed circuit	
V23133-A3001-D152 ¹⁾	1-1414173-0	Form A	AgSnO2	Open	Printed circuit	
24 V pcb relays						
V23133-A1022-C133	3-1393278-7	Form C	AgNi0.15	Open	Printed circuit	
V23133-A1022-D143	3-1393278-9	Form C	AgSnO2	Open	Printed circuit	
V23133-A3022-C132	7-1393278-1	Form A	AgNi0.15	Open	Printed circuit	
V23133-A3022-D142	7-1393278-2	Form A	AgSnO2	Open	Printed circuit	
V23133-A3022-D152 ¹⁾	1-1414174-0	Form A	AgSnO2	Open	Printed circuit	
12 V pcb relays						
V23076-A1001-C133	1393277-4	Form C	AgNi0.15	Sealed	Printed circuit	
V23076-A1001-D143	1393277-6	Form C	AgSnO2	Sealed	Printed circuit	
V23076-A3001-C132	1-1393277-4	Form A	AgNi0.15	Sealed	Printed circuit	
V23076-A3001-D142	1-1393277-7	Form A	AgSnO2	Sealed	Printed circuit	
24 V pcb relays						
V23076-A1022-C133	1393277-8	Form C	AgNi0.15	Sealed	Printed circuit	
V23076-A1022-D143	1393277-9	Form C	AgSnO2	Sealed	Printed circuit	
V23076-A3022-C132	1-1393277-8	Form A	AgNi0.15	Sealed	Printed circuit	
V23076-A3022-D142	1-1393277-9	Form A	AgSnO2	Sealed	Printed circuit	

¹⁾ For indicator lamps.

Coil versions

Coil data for Power K	Rated coil voltage (V)	Coil resistance +/- 10% (Ω)	Must operate voltage (V)	Must release voltage (V)	Allowable overdrive ¹⁾ voltage (V)	
					at 23 °C	at 85 °C
V23133-**001-****	12	90	6.9	1.2	20.8	15.5
V23133-**022-****	24	362	14.1	2.4	41.2	32.5
V23076-**001-****	12	90	6.9	1.2	20.8	15.5
V23076-**022-****	24	362	14.1	2.4	41.2	32

¹⁾ Allowable overdrive is stated with no load applied and minimum coil resistance.

Note: further coils on request.

Standard delivery packs (orders in multiples of delivery pack)

Open version: 500 pieces
Sealed version: 300 pieces

SKYTECH

تهیه و توزیع قطعات الکترونیک